



**FITTING INSTRUCTIONS, INSTRUCTIONS DE MONTAGE,  
EINBAUANLEITUNG, ISTRUZIONI DI MONTAGGIO,  
INSTRUCCIONES DE MOTAJE, 取扱説明書**

**XK**

**Bluetooth telephone system**

**Notes:**

For vehicles already fitted with a telephone system, it will be necessary to check the level of the telephone module prior to fitting a new Bluetooth telephone system.

Connect the vehicle to :-

WDS - Configure phone module, and read the level of module.

If the telephone module is earlier than AC level, replace the telephone module. For instructions on replacing the telephone module: follow 27 -32 for convertible and 33-37 for coupe.

**Notes**

Telephone fitted.

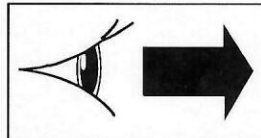

**1.**

**Notes**

No telephone fitted.

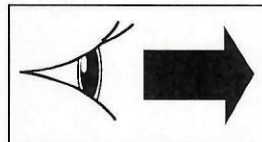

**2.**

**1.**

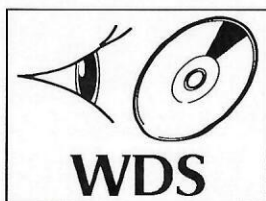

**MY**

**2003**



[www.jaguartechinfo.com/extfree2viewjagprod/index.jsp](http://www.jaguartechinfo.com/extfree2viewjagprod/index.jsp)



FITTING INSTRUCTIONS, INSTRUCTIONS DE MONTAGE,  
EINBAUANLEITUNG, ISTRUZIONI DI MONTAGGIO,  
INSTRUCCIONES DE MONTAJE, 取扱説明書

XK

Bluetooth telephone system

2.

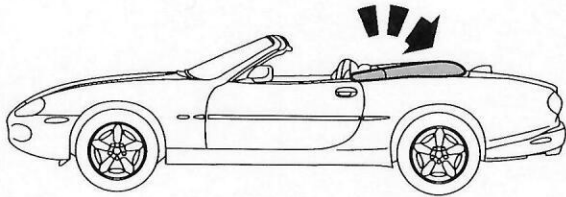

VPK001

Notes:

- 2. Convertible only.

3.

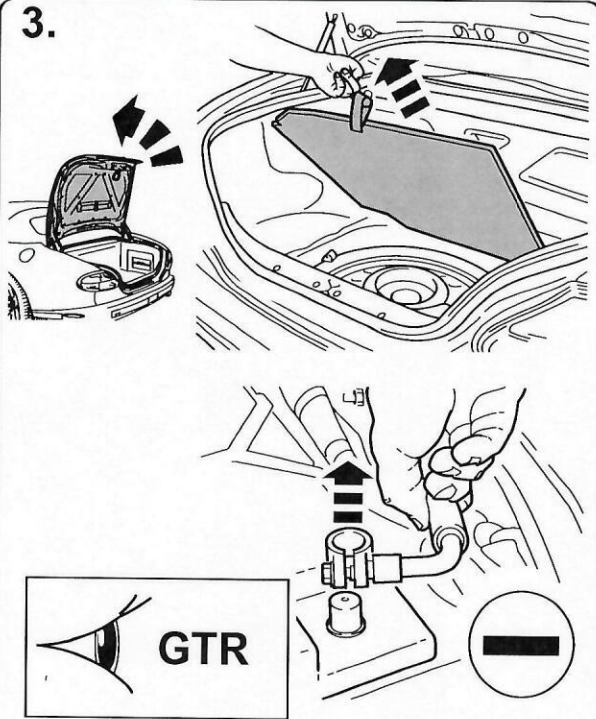

BDK001

Notes:

- 3. Refer to GTR / Drivers Handbook to ensure correct operations are carried out, relevant to battery disconnect and reconnect.

Notes

Telephone fitted.

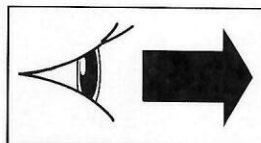

4.

Notes

No telephone fitted.

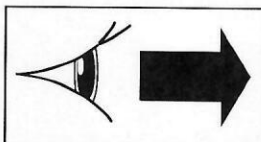

15.

MY 2003 →

[www.jaguartechinfo.com/extfree2viewjagprod/index.jsp](http://www.jaguartechinfo.com/extfree2viewjagprod/index.jsp)

XK

Bluetooth telephone system

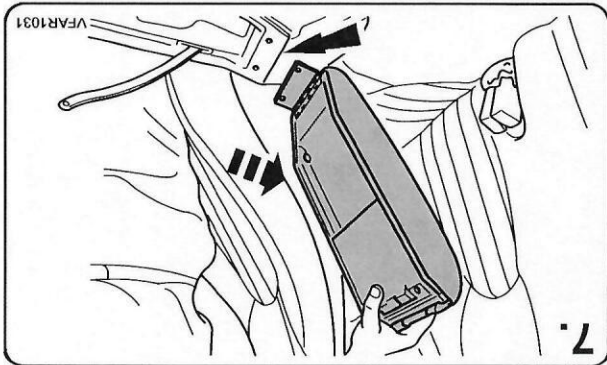
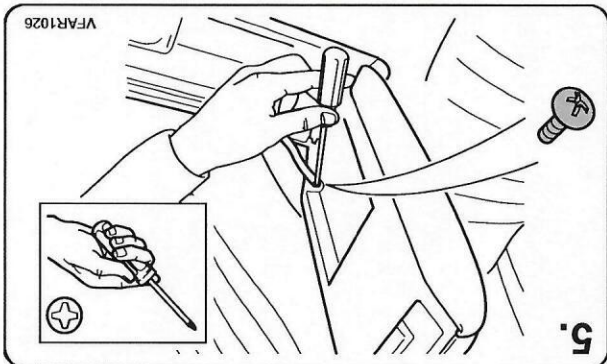
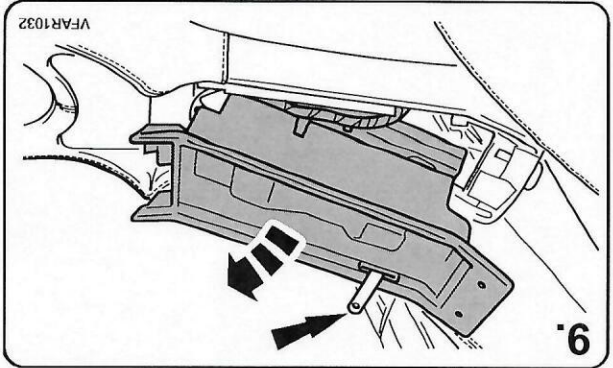
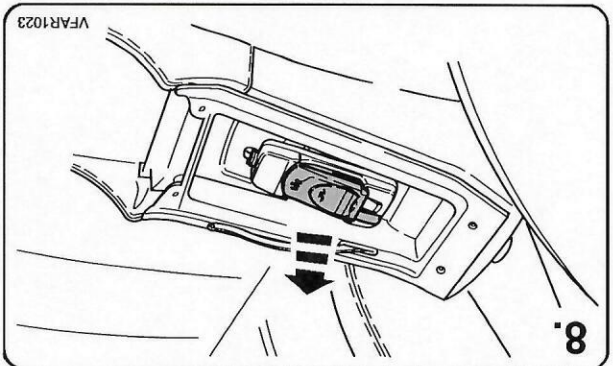
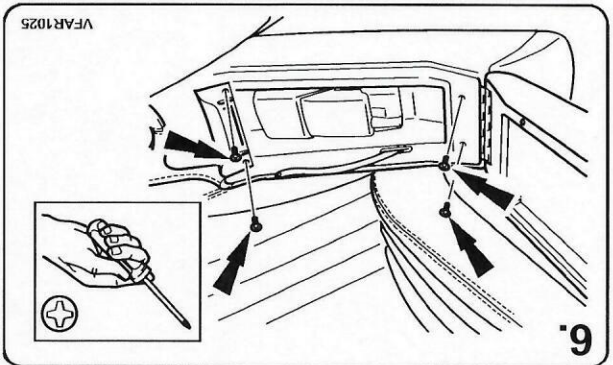
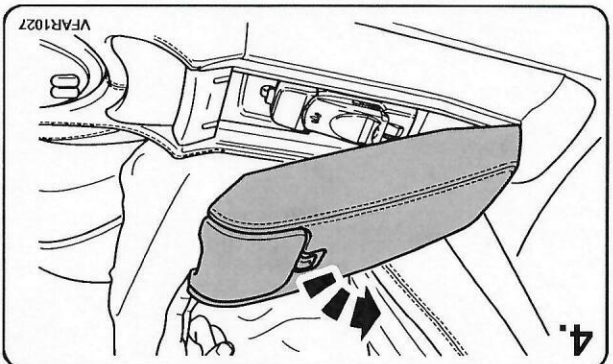



**FITTING INSTRUCTIONS, INSTRUCTIONS DE MONTAGE,  
EINBAUANLEITUNG, ISTRUZIONI DI MONTAGGIO,  
INSTRUCCIONES DE MONTAJE, 取扱説明書**

**XK**

**Bluetooth telephone system**

**10.**

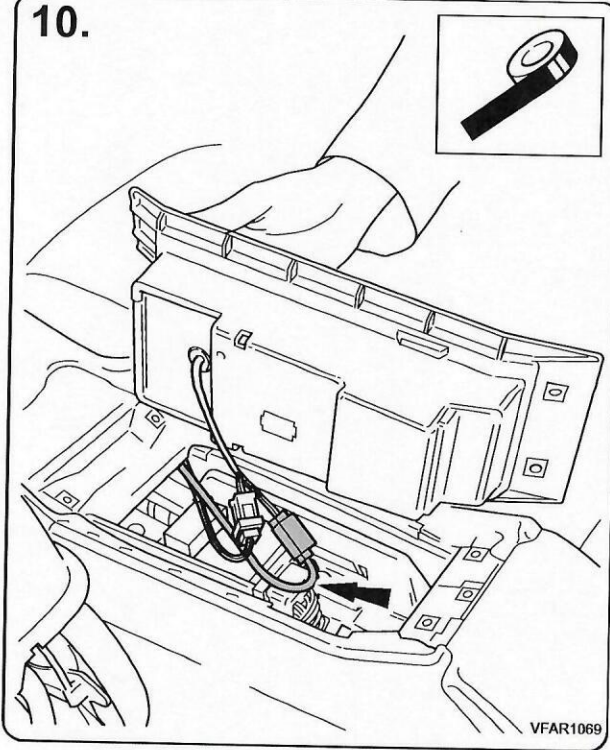

**Notes:**

- 10. When the antenna is disconnected, secure the connector to the vehicle harness.

**11.**

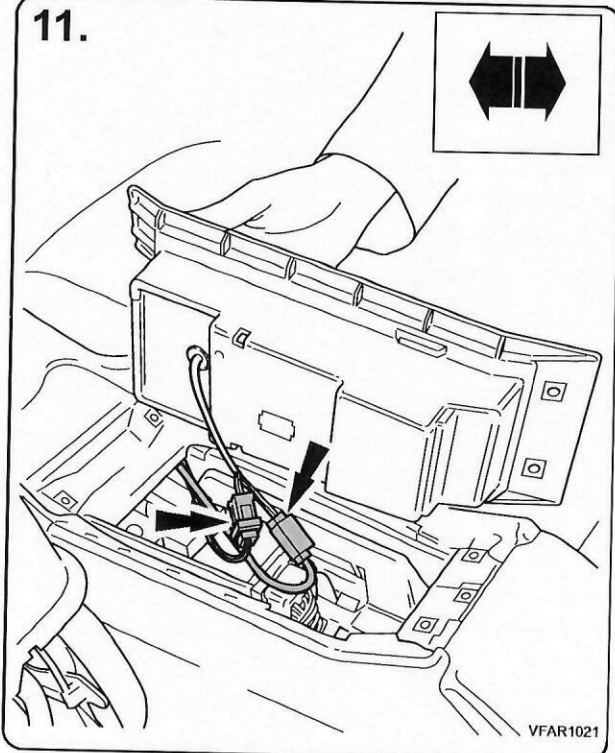

**MY 2003 →**

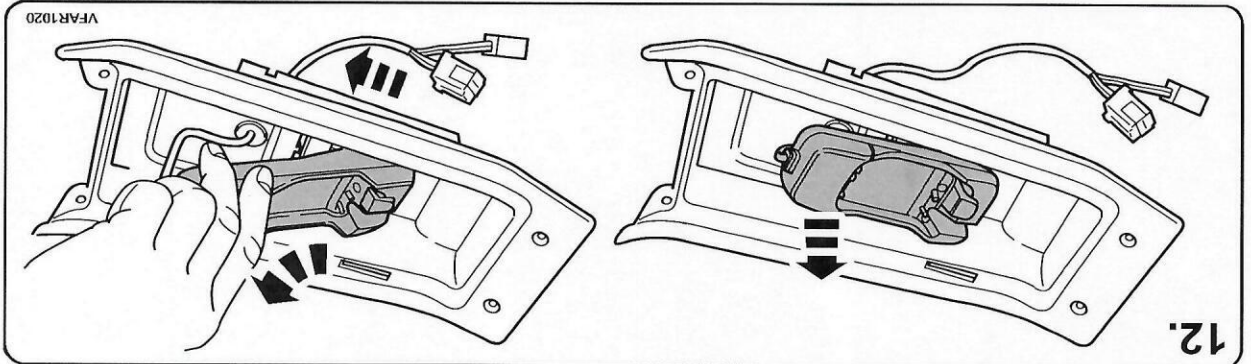
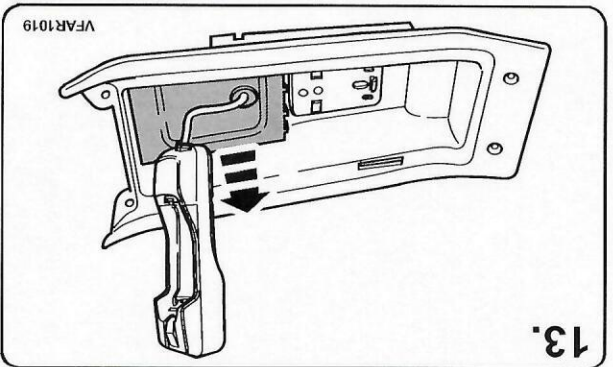
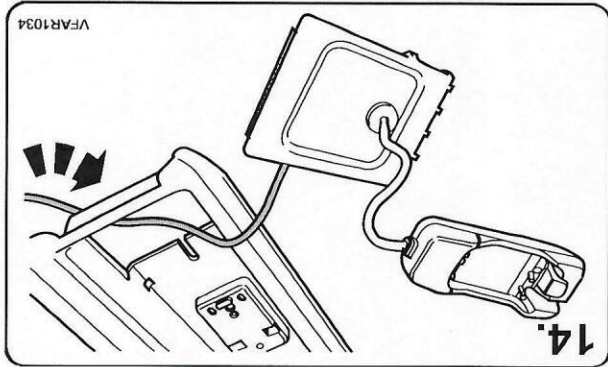
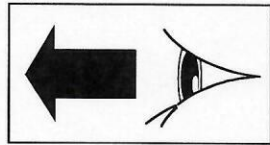
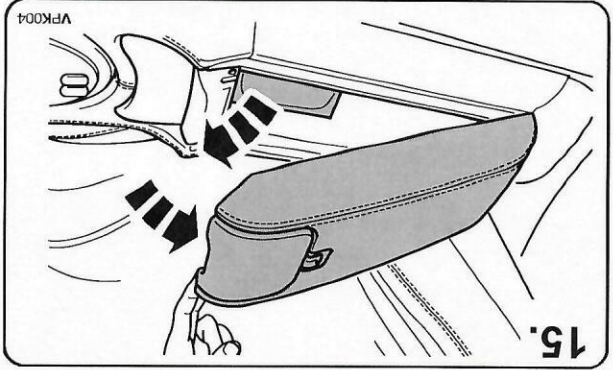

Bluetooth telephone system

XK



**Bluetooth telephone system**

**XK**

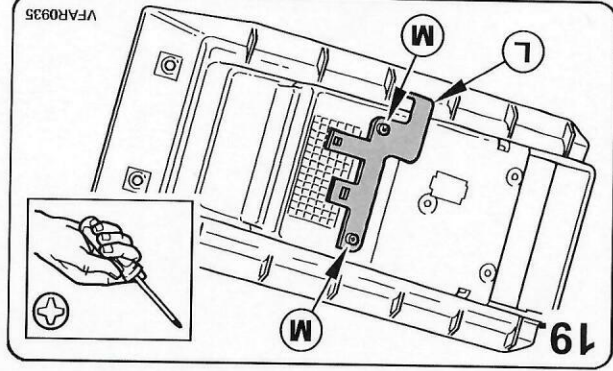
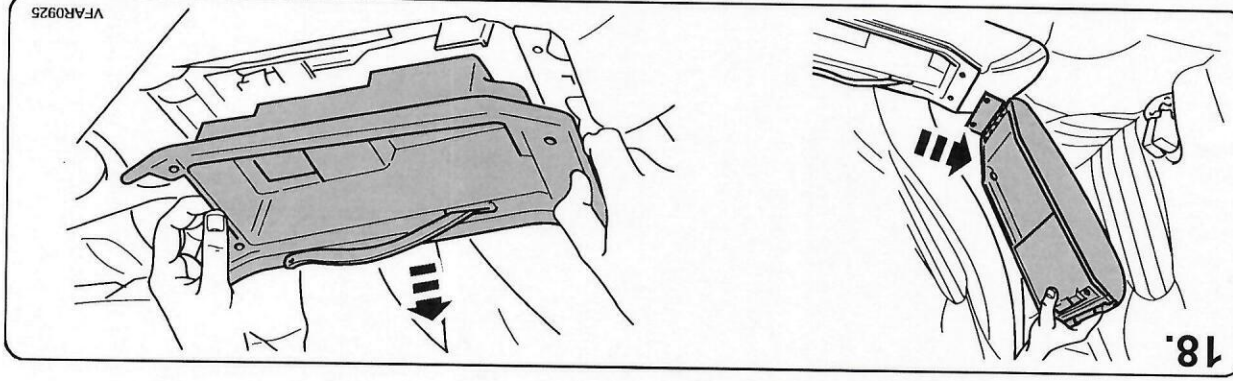
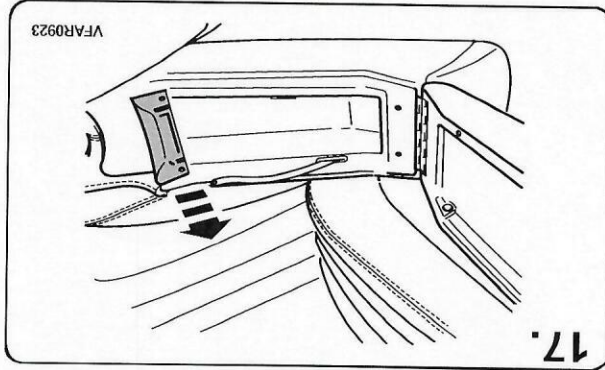
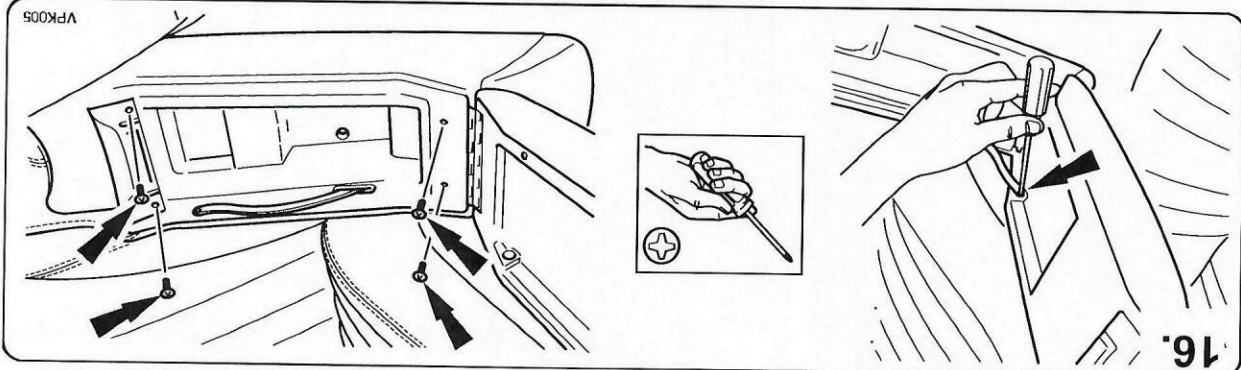

**Notes:**  
19. Fit loom bracket if not already fitted.



FITTING INSTRUCTIONS, INSTRUCTIONS DE MONTAGE,  
EINBAUANLEITUNG, ISTRUZIONI DI MONTAGGIO,  
INSTRUCCIONES DE MOTAJE, 取扱説明書

XK

Bluetooth telephone system

20.

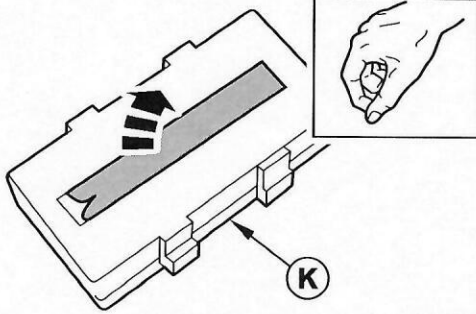

VFAR0927

Notes:

20. Remove the adhesive backing tape.

21.

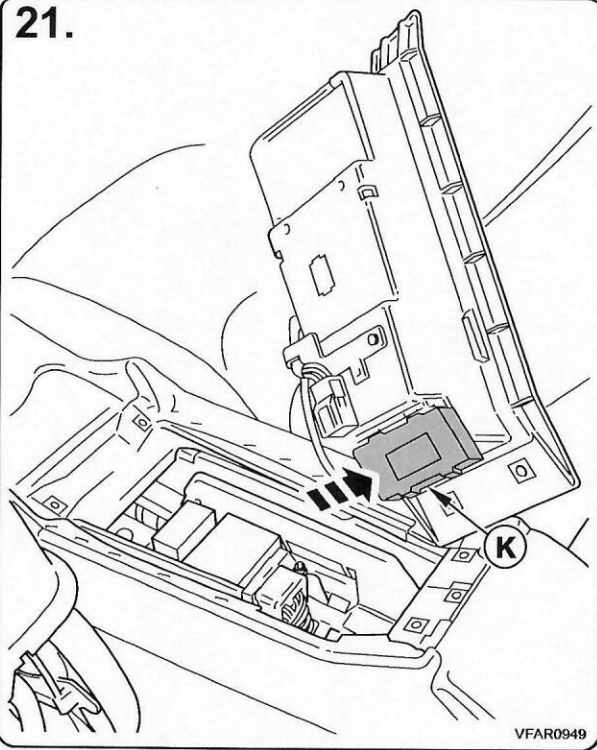

VFAR0949

Notes

If the vehicle requires a microphone to be fitted.

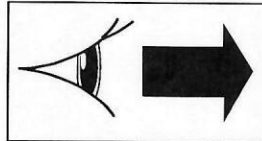

22.

Notes

If the vehicle is already fitted with a microphone.

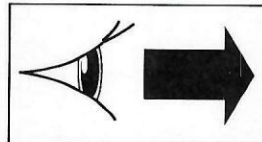

27.

MY 2003 →



**FITTING INSTRUCTIONS, INSTRUCTIONS DE MONTAGE,  
EINBAUANLEITUNG, ISTRUZIONI DI MONTAGGIO,  
INSTRUCCIONES DE MONTAJE, 取扱説明書**

**XK**

**Bluetooth telephone system**

**22.**

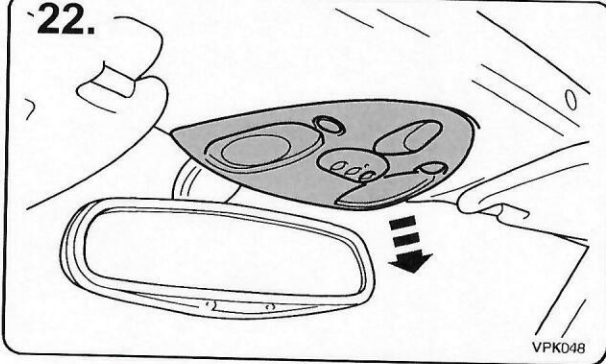

**Notes:**

22. Lower roof console.

**23.**

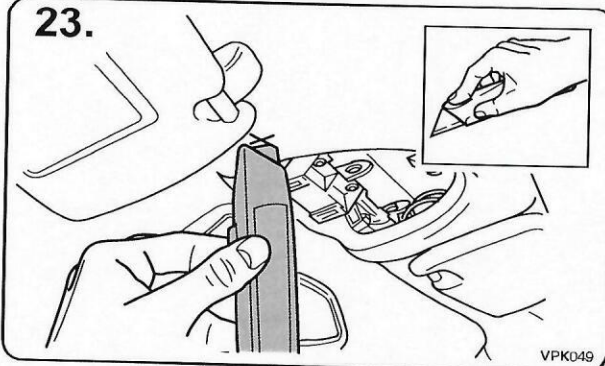

**Notes:**

23. Cut trim alongside aperture to fit microphone.

**24.**

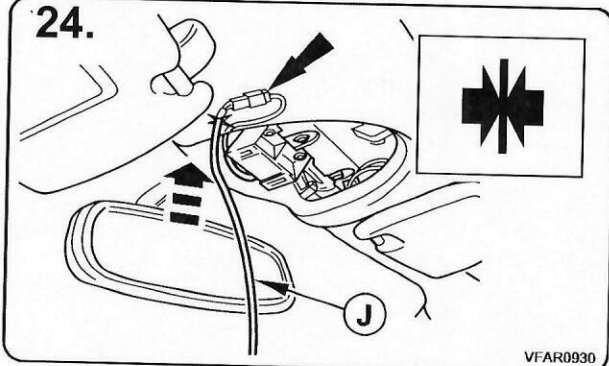

**Notes:**

25. Secure microphone base plate, angled towards the driver.

**25.**

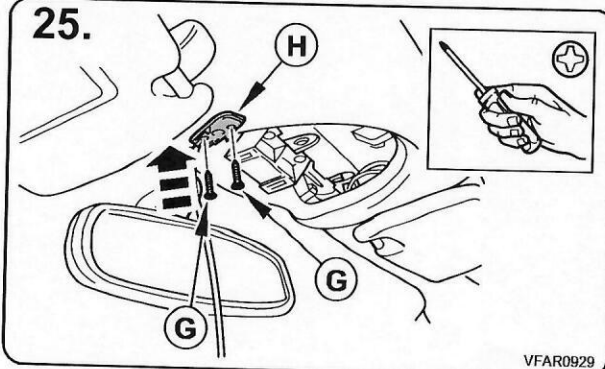

**MY 2003 →**



FITTING INSTRUCTIONS, INSTRUCTIONS DE MONTAGE, EINBAUANLEITUNG, ISTRUZIONI DI MONTAGGIO, INSTRUCCIONES DE MONTAJE, 取扱説明書

XK

Bluetooth telephone system

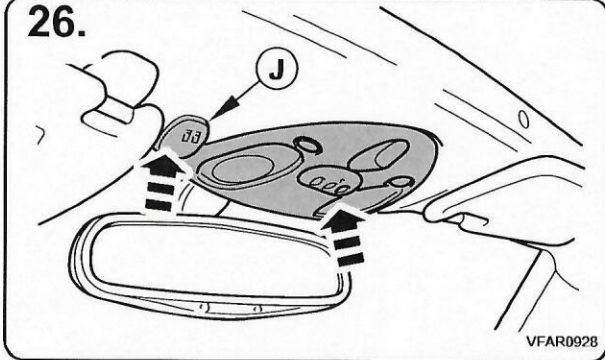

Notes:

26. Fully fit microphone. Refit roof console.

Notes

If the vehicle requires the fitment of a telephone module.

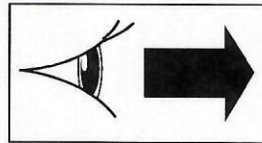

27.

Notes

If the vehicle has a correct level telephone module fitted.

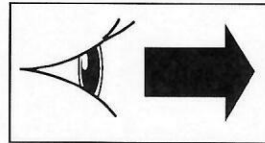

43.

Notes:

Instructions 27 to 32 refer to Convertible only. For Coupe follow instructions 33 to 37.

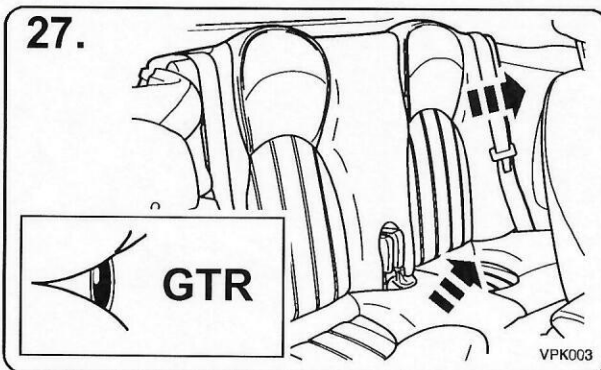

MY 2003 →



FITTING INSTRUCTIONS, INSTRUCTIONS DE MONTAGE,  
EINBAUANLEITUNG, ISTRUZIONI DI MONTAGGIO,  
INSTRUCCIONES DE MONTAJE, 取扱説明書

XK

Bluetooth telephone system

28.

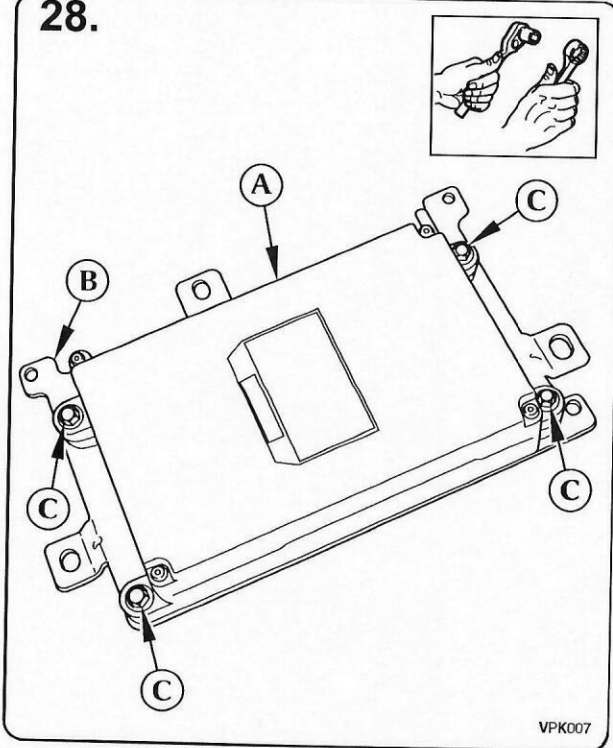

29.

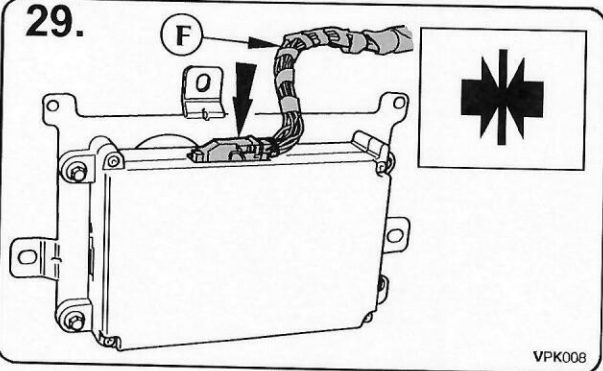

30.

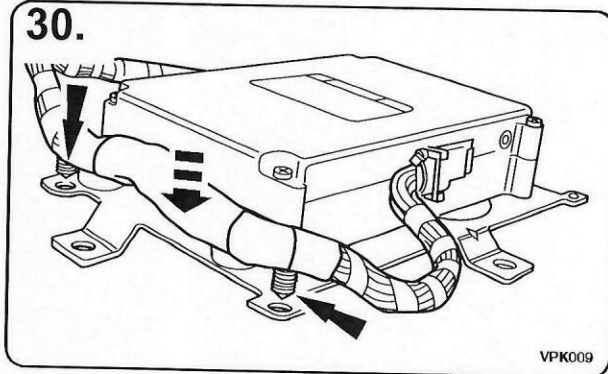

VPK009

31.

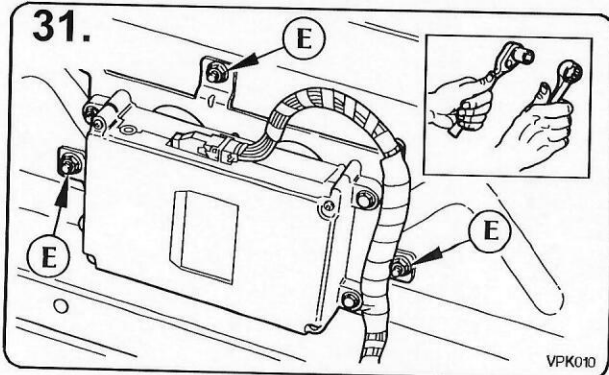

MY 2003 →



FITTING INSTRUCTIONS, INSTRUCTIONS DE MONTAGE,  
EINBAUANLEITUNG, ISTRUZIONI DI MONTAGGIO,  
INSTRUCCIONES DE MONTAJE, 取扱説明書

XK

Bluetooth telephone system

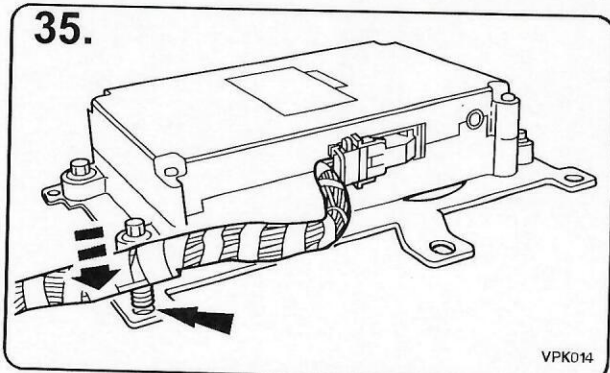
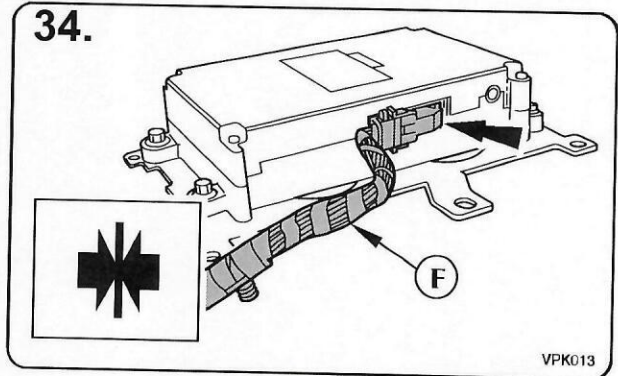
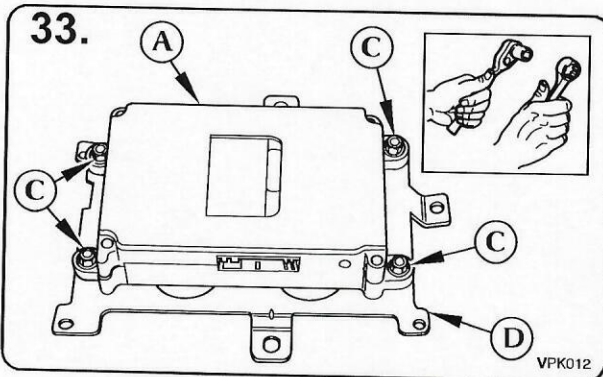
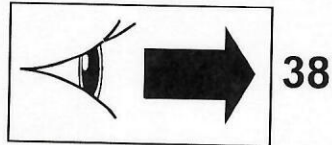
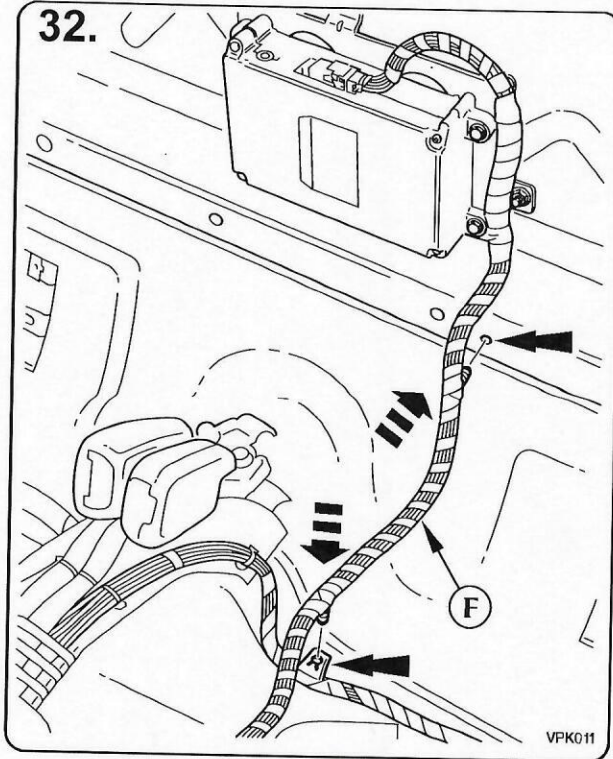

MY 2003 →



FITTING INSTRUCTIONS, INSTRUCTIONS DE MONTAGE,  
EINBAUANLEITUNG, ISTRUZIONI DI MONTAGGIO,  
INSTRUCCIONES DE MOTAJE, 取扱説明書

XK

Bluetooth telephone system

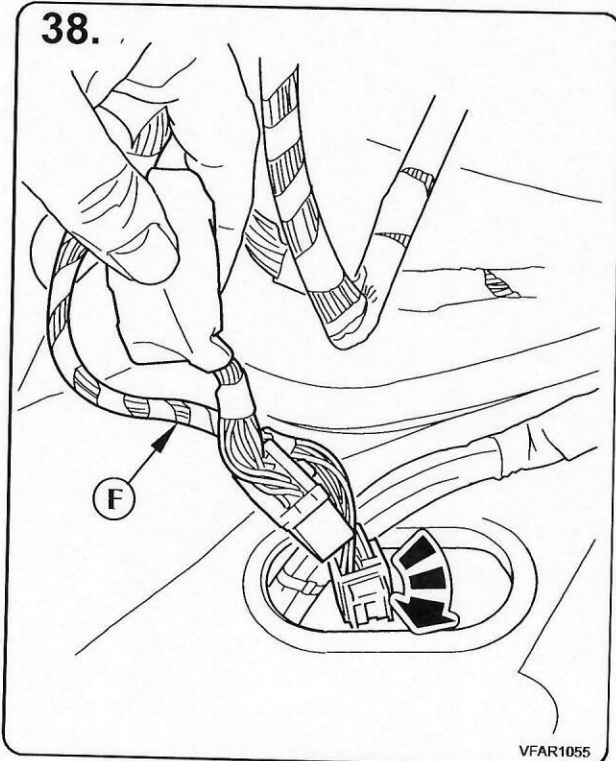
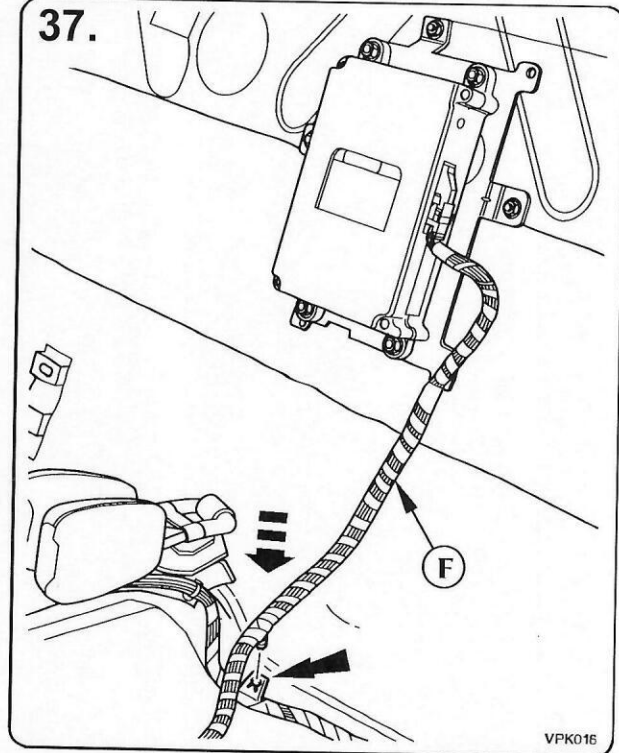
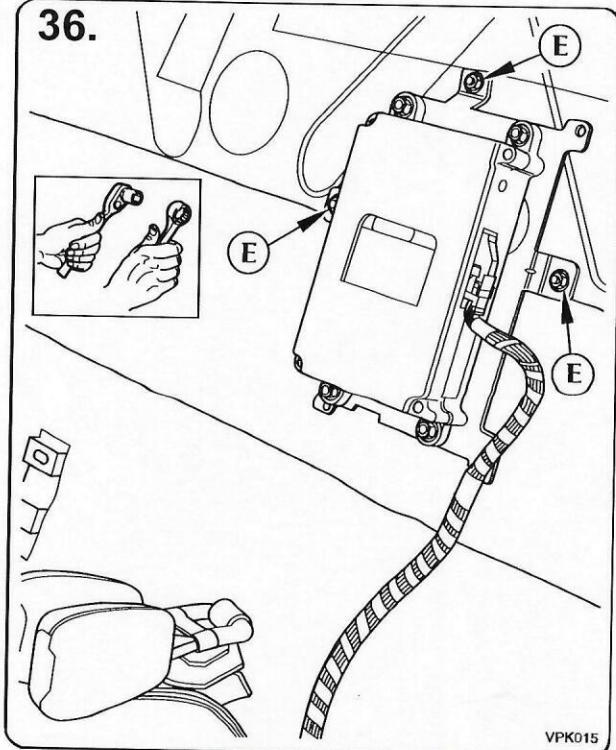

Notes:

38. Route phone harness along centre tunnel, through aperture into the cubby box area.

MY 2003 →

Bluetooth telephone system

XK

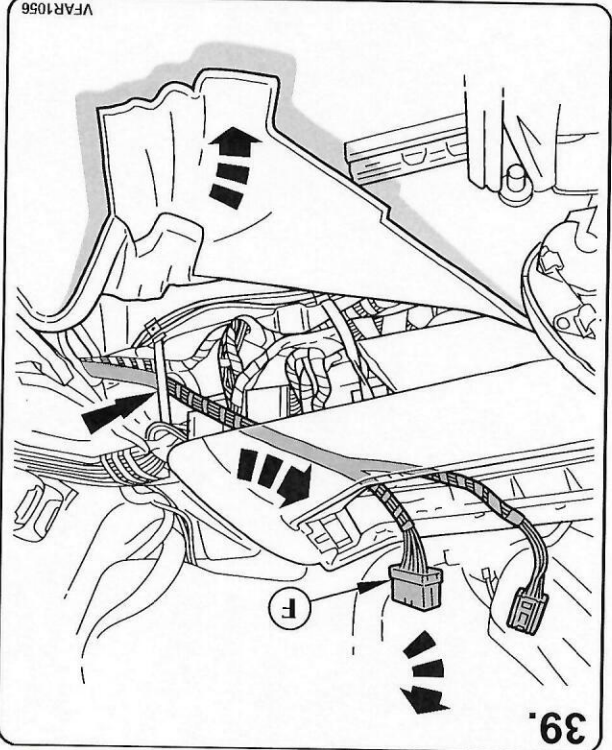

39.

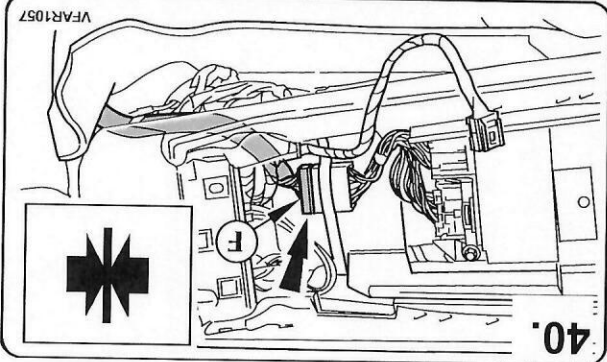

40.

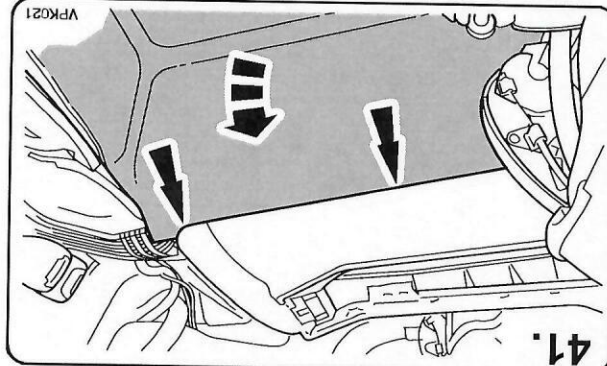

41.

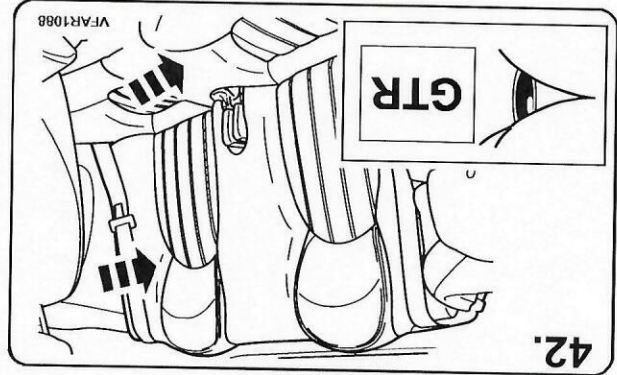

42.

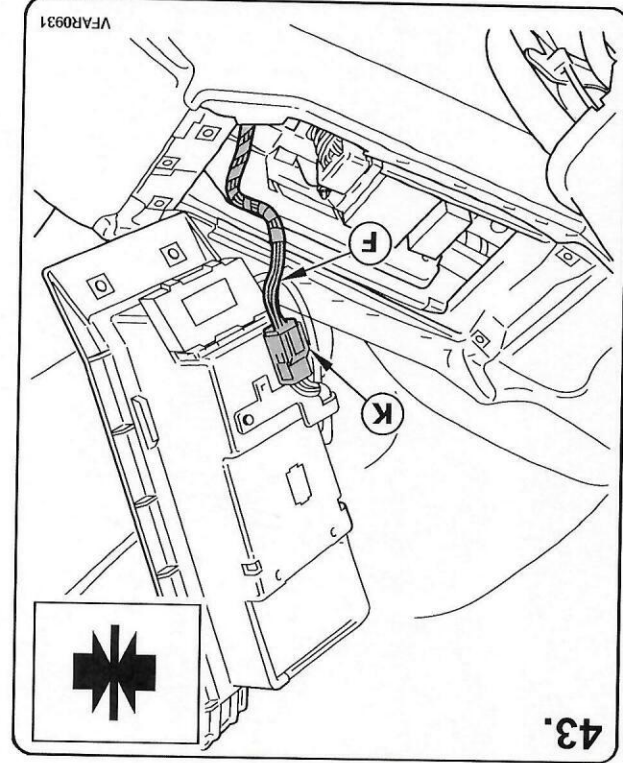

43.

XK

Bluetooth telephone system

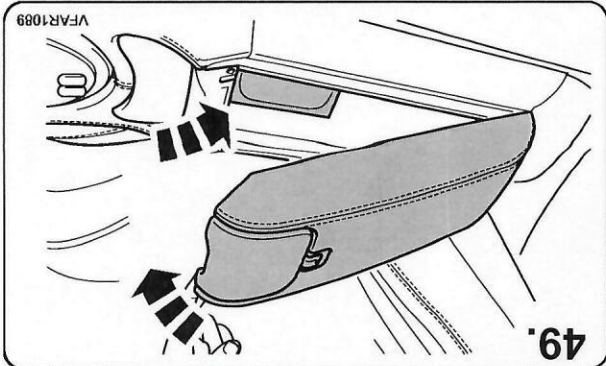
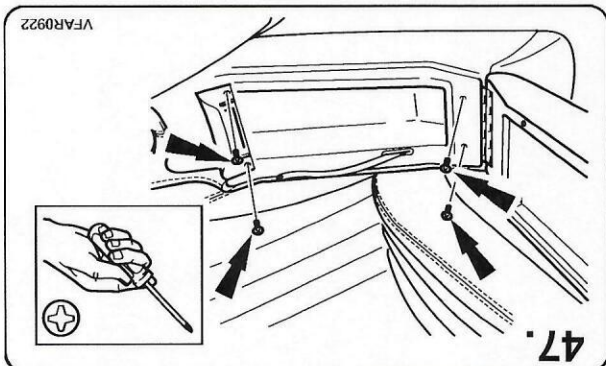
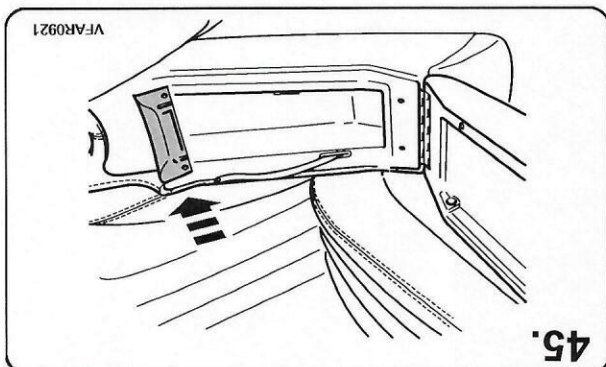
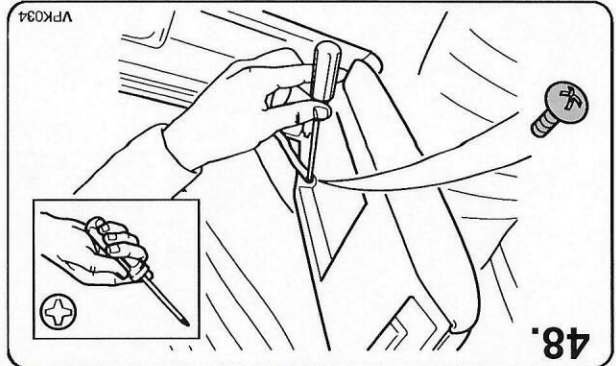
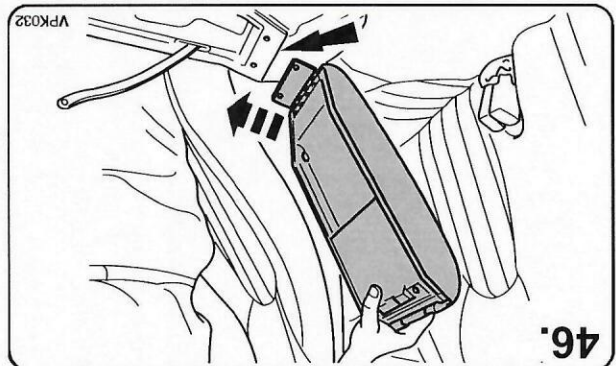
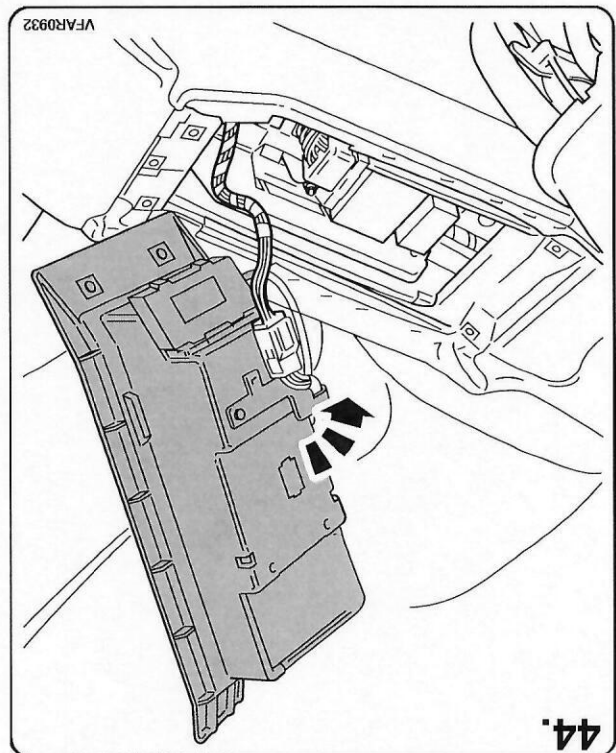

Notes:  
 45. If fitted.



**FITTING INSTRUCTIONS, INSTRUCTIONS DE MONTAGE,  
EINBAUANLEITUNG, ISTRUZIONI DI MONTAGGIO,  
INSTRUCCIONES DE MONTAJE, 取扱説明書**

**XK**

**Bluetooth telephone system**

**50.**

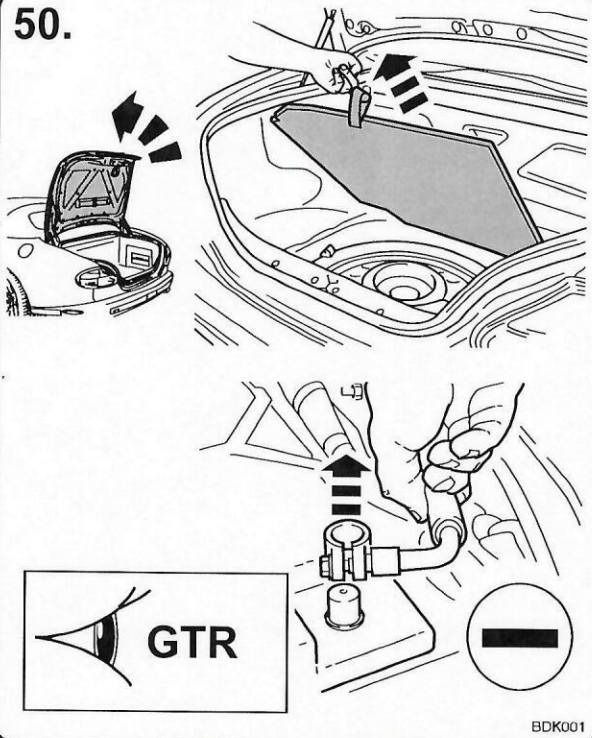

**Notes:**

50. Refer to GTR / Drivers Handbook to ensure correct operations are carried out, relevant to battery disconnect and reconnect.

**51.**

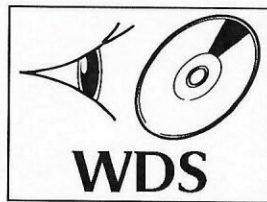

**Notes:**

51. If a new telephone module has been fitted. Refer to WDS. Dealer options, add and remove accessories.

**52.**

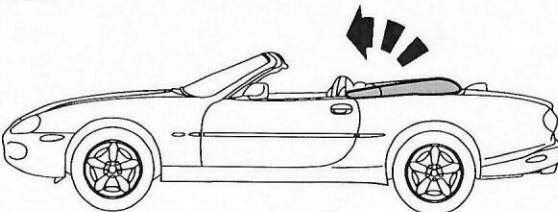

**MY 2003 →**

[www.jaguartechno.com/extfree2viewiagprod/index.jsp](http://www.jaguartechno.com/extfree2viewiagprod/index.jsp)